

CYAL50233107  
 © Ordnance Survey Ireland. All rights reserved.



Sheet No.  
11257-1009

Sheet No.  
11257-1008

Sheet No.  
11257-1004

Sheet No.  
11257-1003

Sheet No.  
11257-1002

Sheet No.  
11257-1001

Sheet No.  
11257-1005

Sheet No.  
11257-1006

Sheet No.  
11257-1007

- NOTES:**
- FIGURED DIMENSIONS ONLY TO BE TAKEN FROM THIS DRAWING
  - ALL DRAWINGS TO BE CHECKED BY THE CONTRACTOR ON SITE
- ENGINEER TO BE INFORMED BY THE CONTRACTOR OF ANY DISCREPANCIES BEFORE ANY WORKS COMMENCES
- ALL LEVELS SHOWN RELATE TO ORDNANCE SURVEY DATUM AT MALIN HEAD, THE GEOGRAPHIC COORDINATE SYSTEM IS TO IRISH TRANSVERSE MERCATOR (ITM)

Rev.	Date	Description	By	Chkd
D01	Oct 22	Draft Issue for review	JD	JN

Client  Comhairle Contae an Chabháin  
Cavan County Council

Project  
Kingscourt Public Realm Enhancement Scheme

Title  
Preliminary Drainage Design

Sheet 8 of 9

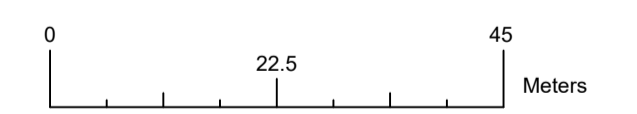

Scale @ A1:1:750

Prepared by: JD	Checked JN	Date Oct 2022
Project Director S. Kelly	Drawing Status Draft	



TOBIN Consulting Engineers will not be liable for any use of this document for any purpose other than that for which it was originally prepared and provided. Except where specifically and explicitly agreed in writing by TOBIN Consulting Engineers, no copyright holder, no part of this document may be reproduced or transmitted in any form and this document shall not be relied upon by any third party for any purpose.

Drawing No. **11257 - 1000** D01

Layout Plan  
Scale @ A1:1:750

**ALL MATERIALS AND FINISHES SHOWN ARE SUBJECT TO FURTHER DETAILED DESIGN**

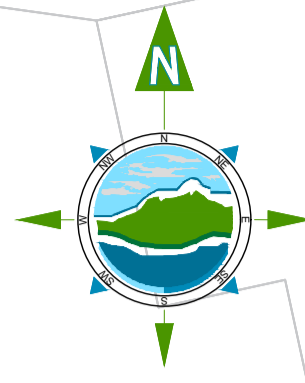

CYAL50233107  
© Ordnance Survey Ireland. All rights reserved.

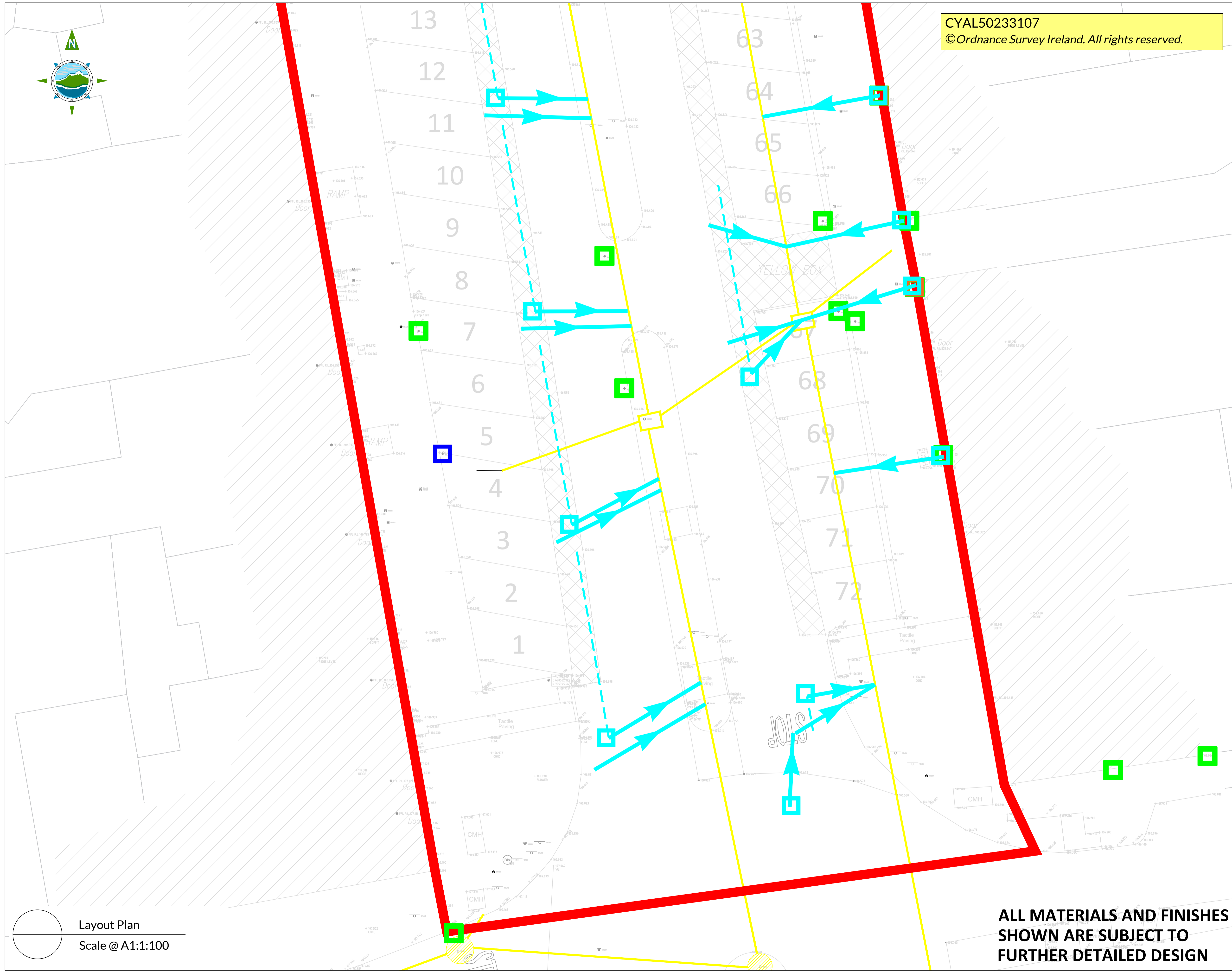

- LEGEND**
- EXISTING GULLY
  - EXISTING DOWNPIPE GULLY
  - PROPOSED GULLY
  - RETAINED GULLY
  - PROPOSED STORM LINE
  - EXISTING STORM LINE
  - SuDS - EXTENT OF TREE PIT
  - OVERFLOW FROM SuDS (TREE PIT)
  - ACO DRAIN WITH GRATING

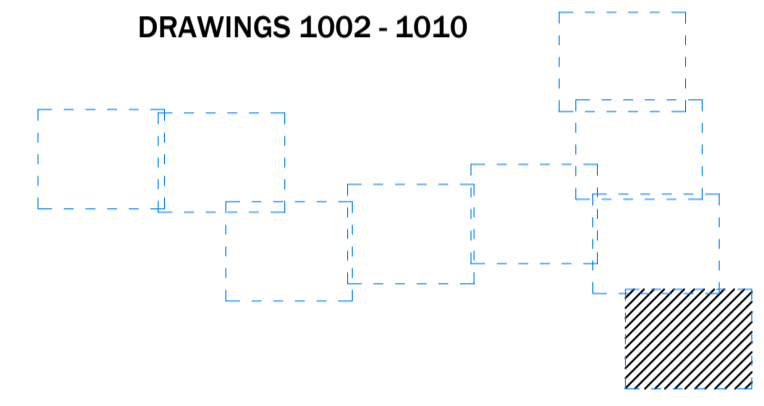

- NOTES:**
1. FIGURED DIMENSIONS ONLY TO BE TAKEN FROM THIS DRAWING
  2. ALL DRAWINGS TO BE CHECKED BY THE CONTRACTOR ON SITE
- ENGINEER TO BE INFORMED BY THE CONTRACTOR OF ANY DISCREPANCIES BEFORE ANY WORKS COMMENCES
- ALL LEVELS SHOWN RELATE TO ORDNANCE SURVEY DATUM AT MALIN HEAD, THE GEOGRAPHIC COORDINATE SYSTEM IS TO IRISH TRANSVERSE MERCATOR (ITM)

Rev.	Date	Description	By	Chkd
D01	Oct 22	Draft Issue for review	JD	JN

Client Comhairle Contae an Chabháin  
Cavan County Council

Project  
Kingscourt Public Realm Enhancement Scheme

Title  
Preliminary Drainage Design

Sheet 8 of 9

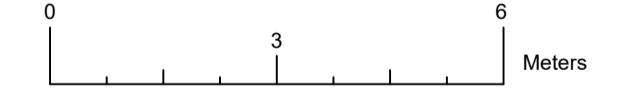

Scale @ A1:1:100

Prepared by: JD	Checked JN	Date Oct 2022
Project Director	S. Kelly	
Drawing Status	Draft	



TOBIN Consulting Engineers will not be liable for any use of this document for any purpose other than that for which it was originally prepared and provided. Except where specifically and explicitly agreed in writing by TOBIN Consulting Engineers, no copyright holder, no part of this document may be reproduced or transmitted in any form and this document shall not be relied upon by any third party for any purpose.

Drawing No. **11257 - 1001** D01

Layout Plan  
Scale @ A1:1:100

**ALL MATERIALS AND FINISHES SHOWN ARE SUBJECT TO FURTHER DETAILED DESIGN**

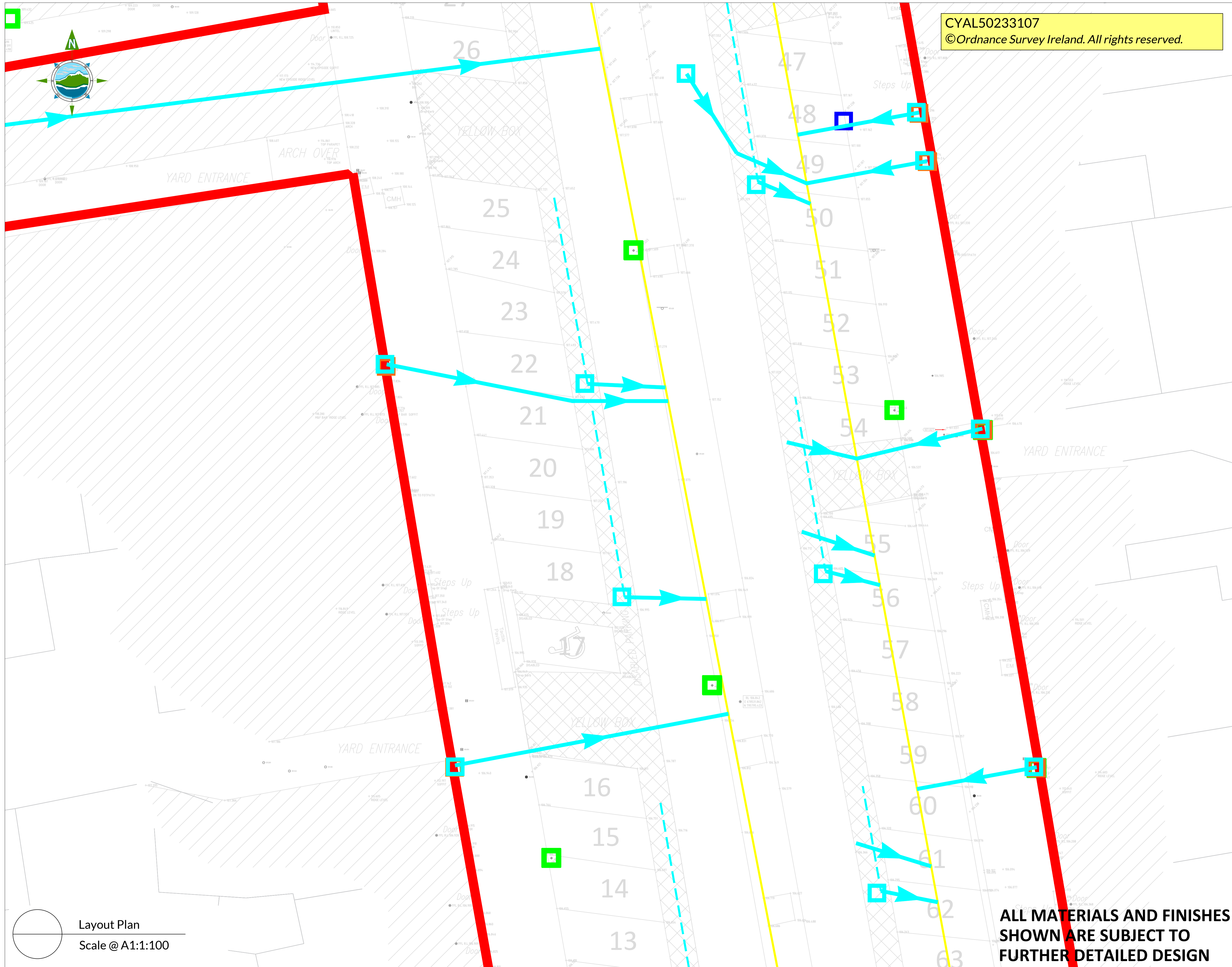

CYAL50233107  
© Ordnance Survey Ireland. All rights reserved.

- LEGEND**
- EXISTING GULLY
  - EXISTING DOWNPIPE GULLY
  - PROPOSED GULLY
  - RETAINED GULLY
  - PROPOSED STORM LINE
  - EXISTING STORM LINE
  - SUDS - EXTENT OF TREE PIT
  - OVERFLOW FROM SUDS (TREE PIT)
  - ACO DRAIN WITH GRATING

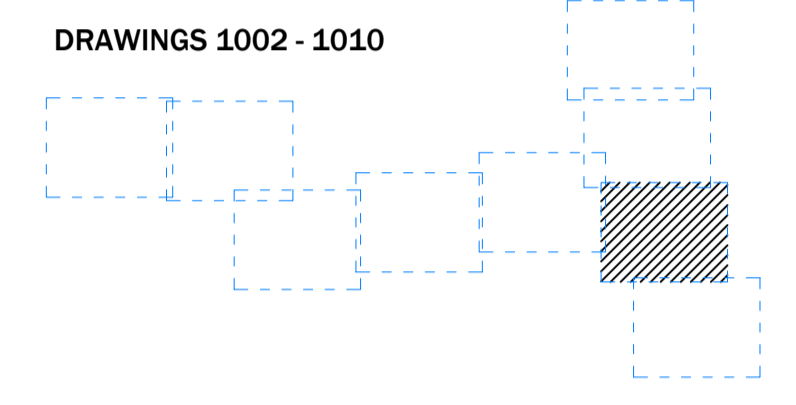

- NOTES:**
- FIGURED DIMENSIONS ONLY TO BE TAKEN FROM THIS DRAWING
  - ALL DRAWINGS TO BE CHECKED BY THE CONTRACTOR ON SITE
- ENGINEER TO BE INFORMED BY THE CONTRACTOR OF ANY DISCREPANCIES BEFORE ANY WORKS COMMENCES
- ALL LEVELS SHOWN RELATE TO ORDNANCE SURVEY DATUM AT MALIN HEAD, THE GEOGRAPHIC COORDINATE SYSTEM IS TO IRISH TRANSVERSE MERCATOR (ITM)

D01	Oct 22	Draft Issue for review	JD JN
Rev.	Date	Description	By Chkd
Client	Comhairle Contae an Chabháin Cavan County Council		
Project	Kingscourt Public Realm Enhancement Scheme		
Title	Preliminary Drainage Design		
Sheet 8 of 9			

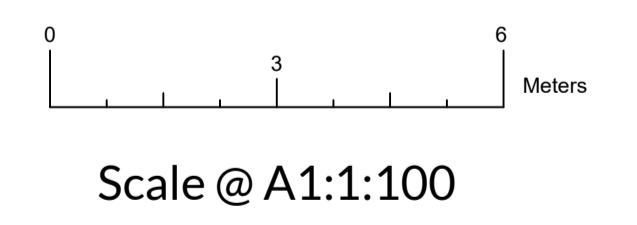

Prepared by:	Checked	Date
JD	JN	Oct 2022
Project Director	S. Kelly	
Drawing Status	Draft	

**TOBIN** CONSULTING ENGINEERS  
CUNNANE STRATTON REYNOLDS LAND PLANNING & DESIGN

**architects** MALLEN ARCHITECTS

TOBIN Consulting Engineers will not be liable for any use of this document for any purpose other than that for which it was originally prepared and provided. Except where specifically and explicitly agreed in writing by TOBIN Consulting Engineers, no copyright holder, no part of this document may be reproduced or transmitted in any form and this document shall not be relied upon by any third party for any purpose.

Drawing No. **11257 - 1002** D01

Layout Plan  
Scale @ A1:1:100

**ALL MATERIALS AND FINISHES SHOWN ARE SUBJECT TO FURTHER DETAILED DESIGN**

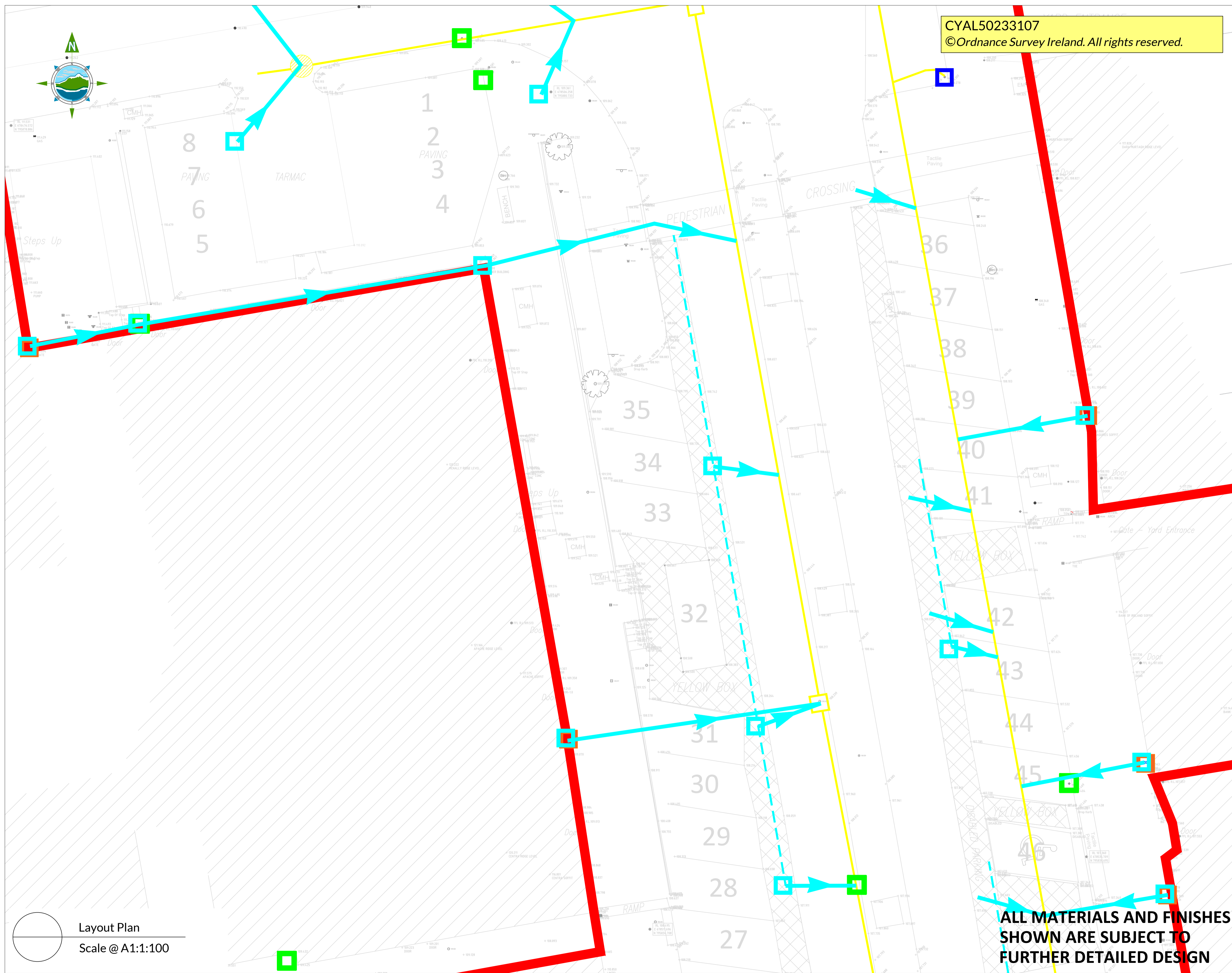

- LEGEND**
- EXISTING GULLY
  - EXISTING DOWNPIPE GULLY
  - PROPOSED GULLY
  - RETAINED GULLY
  - PROPOSED STORM LINE
  - EXISTING STORM LINE
  - SuDS - EXTENT OF TREE PIT
  - OVERFLOW FROM SuDS (TREE PIT)
  - - - ACO DRAIN WITH GRATING

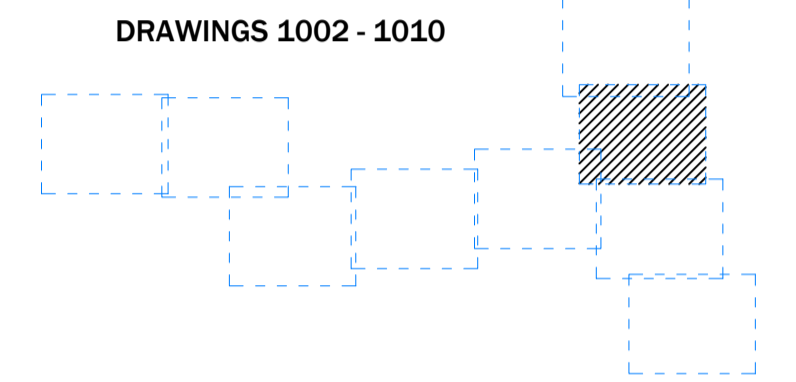

- NOTES:**
1. FIGURED DIMENSIONS ONLY TO BE TAKEN FROM THIS DRAWING
  2. ALL DRAWINGS TO BE CHECKED BY THE CONTRACTOR ON SITE
- ENGINEER TO BE INFORMED BY THE CONTRACTOR OF ANY DISCREPANCIES BEFORE ANY WORKS COMMENCES
- ALL LEVELS SHOWN RELATE TO ORDNANCE SURVEY DATUM AT MALIN HEAD, THE GEOGRAPHIC COORDINATE SYSTEM IS TO IRISH TRANSVERSE MERCATOR (ITM)

D01	Oct 22	Draft Issue for review	JD	JN
Rev.	Date	Description	By	Chkd
Client		Comhairle Contae an Chabháin Cavan County Council		
Project		Kingscourt Public Realm Enhancement Scheme		
Title		Preliminary Drainage Design		
Sheet		8 of 9		

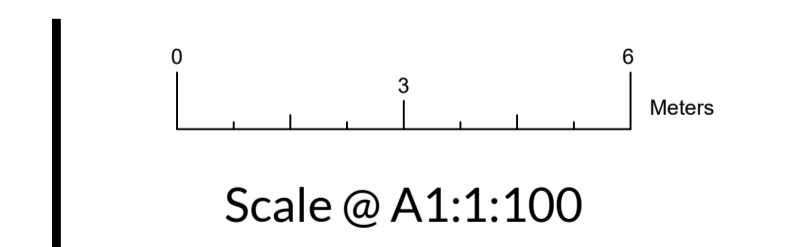

Prepared by:	Checked	Date
JD	JN	Oct 2022
Project Director	S. Kelly	
Drawing Status	Draft	

**TOBIN** CONSULTING ENGINEERS  
 CUNNANE STRATTON REYNOLDS LAND PLANNING & DESIGN  
 architects

Layout Plan  
 Scale @ A1:1:100

**ALL MATERIALS AND FINISHES SHOWN ARE SUBJECT TO FURTHER DETAILED DESIGN**

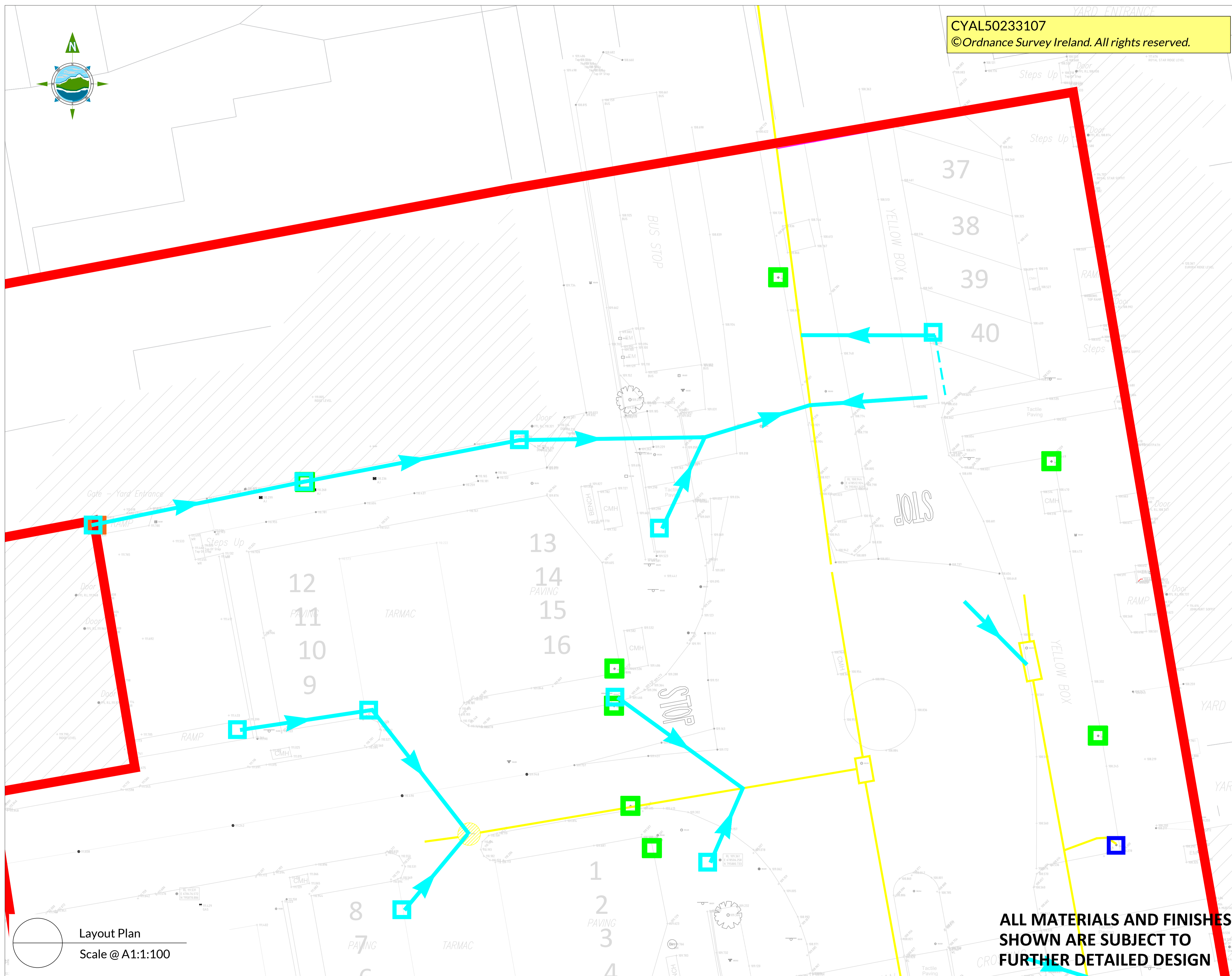

- LEGEND**
- EXISTING GULLY
  - EXISTING DOWNPIPE GULLY
  - PROPOSED GULLY
  - RETAINED GULLY
  - PROPOSED STORM LINE
  - EXISTING STORM LINE
  - SuDS - EXTENT OF TREE PIT
  - OVERFLOW FROM SuDS (TREE PIT)
  - ACO DRAIN WITH GRATING

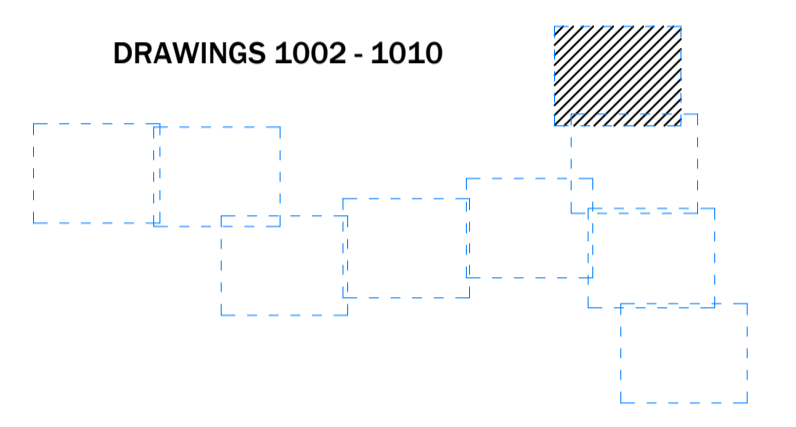

- NOTES:**
1. FIGURED DIMENSIONS ONLY TO BE TAKEN FROM THIS DRAWING
  2. ALL DRAWINGS TO BE CHECKED BY THE CONTRACTOR ON SITE
- ENGINEER TO BE INFORMED BY THE CONTRACTOR OF ANY DISCREPANCIES BEFORE ANY WORKS COMMENCES
- ALL LEVELS SHOWN RELATE TO ORDNANCE SURVEY DATUM AT MALIN HEAD, THE GEOGRAPHIC COORDINATE SYSTEM IS TO IRISH TRANSVERSE MERCATOR (ITM)

D01	Oct 22	Draft Issue for review	JD JN
Rev.	Date	Description	By Chkd
Client	Comhairle Contae an Chabháin Cavan County Council		
Project	Kingscourt Public Realm Enhancement Scheme		
Title	Preliminary Drainage Design		
Sheet 8 of 9			

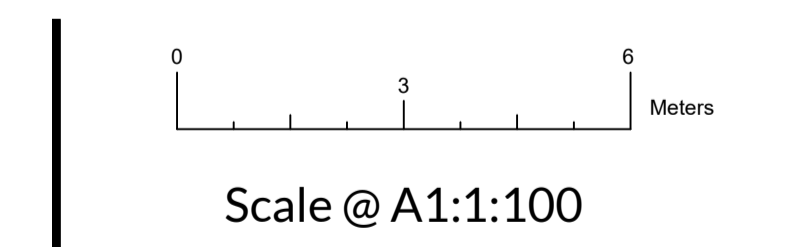

Prepared by:	Checked	Date
JD	JN	Oct 2022
Project Director	S. Kelly	
Drawing Status	Draft	

**TOBIN** CONSULTING ENGINEERS  
CUNNANE STRATTON REYNOLDS LAND PLANNING & DESIGN

**architects**

Layout Plan  
Scale @ A1:1:100

**ALL MATERIALS AND FINISHES SHOWN ARE SUBJECT TO FURTHER DETAILED DESIGN**

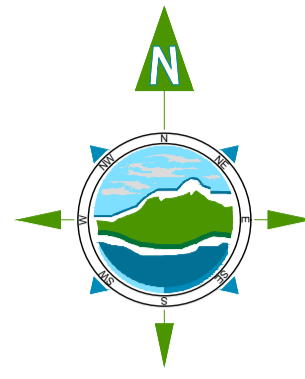

CYAL50233107  
© Ordnance Survey Ireland. All rights reserved.



- LEGEND**
- EXISTING GULLY
  - EXISTING DOWNPIPE GULLY
  - PROPOSED GULLY
  - RETAINED GULLY
  - ACCESS CHAMBER (TO OIL/WATER SEPARATOR)
  - PROPOSED STORM LINE
  - SuDS - EXTENT OF TREE PIT
  - OVERFLOW FROM SuDS (TREE PIT)
  - ACO DRAIN WITH GRATING

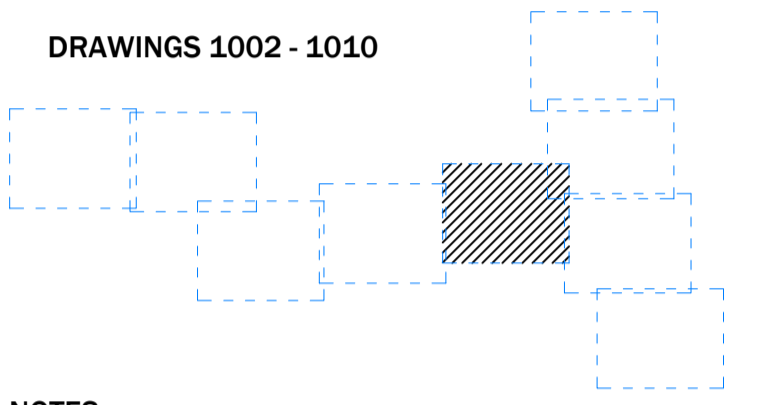

- NOTES:**
- FIGURED DIMENSIONS ONLY TO BE TAKEN FROM THIS DRAWING
  - ALL DRAWINGS TO BE CHECKED BY THE CONTRACTOR ON SITE
- ENGINEER TO BE INFORMED BY THE CONTRACTOR OF ANY DISCREPANCIES BEFORE ANY WORKS COMMENCES
- ALL LEVELS SHOWN RELATE TO ORDNANCE SURVEY DATUM AT MALIN HEAD, THE GEOGRAPHIC COORDINATE SYSTEM IS TO IRISH TRANSVERSE MERCATOR (ITM)

D01	Oct 22	Draft Issue for review	JD JN
Rev.	Date	Description	By Chkd
Client	Comhairle Contae an Chabháin Cavan County Council		
Project	Kingscourt Public Realm Enhancement Scheme		
Title	Preliminary Drainage Design		
Sheet 8 of 9			

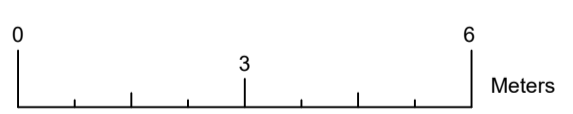

Scale @ A1:1:100

Prepared by:	Checked	Date
JD	JN	Oct 2022
Project Director	S. Kelly	
Drawing Status	Draft	

**TOBIN** CONSULTING ENGINEERS  
CUNNANE STRATTON REYNOLDS LAND PLANNING & DESIGN

**architects** HALL ARCHITECTS

TOBIN Consulting Engineers will not be liable for any use of this document for any purpose other than that for which it was originally prepared and provided. Except where specifically and explicitly agreed in writing by TOBIN Consulting Engineers, no copyright holder, no part of this document may be reproduced or transmitted in any form and this document shall not be relied upon by any third party for any purpose.

Drawing No. **11257 - 1005** D01

Layout Plan  
Scale @ A1:1:100

**ALL MATERIALS AND FINISHES SHOWN ARE SUBJECT TO FURTHER DETAILED DESIGN**

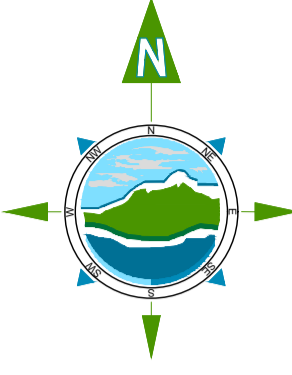

CYAL50233107  
© Ordnance Survey Ireland. All rights reserved.



- LEGEND**
- EXISTING GULLY
  - EXISTING DOWNPIPE GULLY
  - PROPOSED GULLY
  - RETAINED GULLY
  - PROPOSED STORM LINE
  - EXISTING STORM LINE
  - SuDS - EXTENT OF TREE PIT
  - OVERFLOW FROM SuDS (TREE PIT)
  - ACO DRAIN WITH GRATING

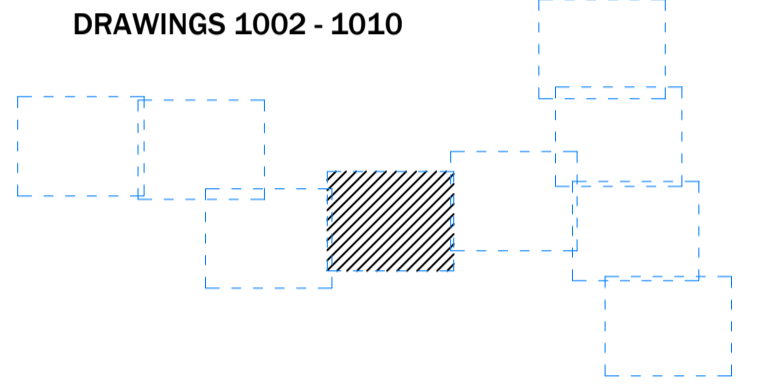

- NOTES:**
1. FIGURED DIMENSIONS ONLY TO BE TAKEN FROM THIS DRAWING
  2. ALL DRAWINGS TO BE CHECKED BY THE CONTRACTOR ON SITE
- ENGINEER TO BE INFORMED BY THE CONTRACTOR OF ANY DISCREPANCIES BEFORE ANY WORKS COMMENCES
- ALL LEVELS SHOWN RELATE TO ORDNANCE SURVEY DATUM AT MALIN HEAD, THE GEOGRAPHIC COORDINATE SYSTEM IS TO IRISH TRANSVERSE MERCATOR (ITM)

D01	Oct 22	Draft Issue for review	JD JN
Rev.	Date	Description	By Chkd
Client		Comhairle Contae an Chabháin Cavan County Council	
Project			
Kingscourt Public Realm Enhancement Scheme			
Title			
Preliminary Drainage Design			
Sheet 8 of 9			

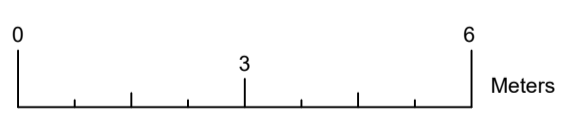

Scale @ A1:1:100

Prepared by:	Checked	Date
JD	JN	Oct 2022
Project Director	S. Kelly	
Drawing Status	Draft	



TOBIN Consulting Engineers will not be liable for any use of this document for any purpose other than that for which it was originally prepared and provided. Except where specifically and explicitly agreed in writing by TOBIN Consulting Engineers, no copyright holder, no part of this document may be reproduced or transmitted in any form and this document shall not be relied upon by any third party for any purpose.

Drawing No. **11257 - 1006** **D01**

Layout Plan  
Scale @ A1:1:100

**ALL MATERIALS AND FINISHES SHOWN ARE SUBJECT TO FURTHER DETAILED DESIGN**

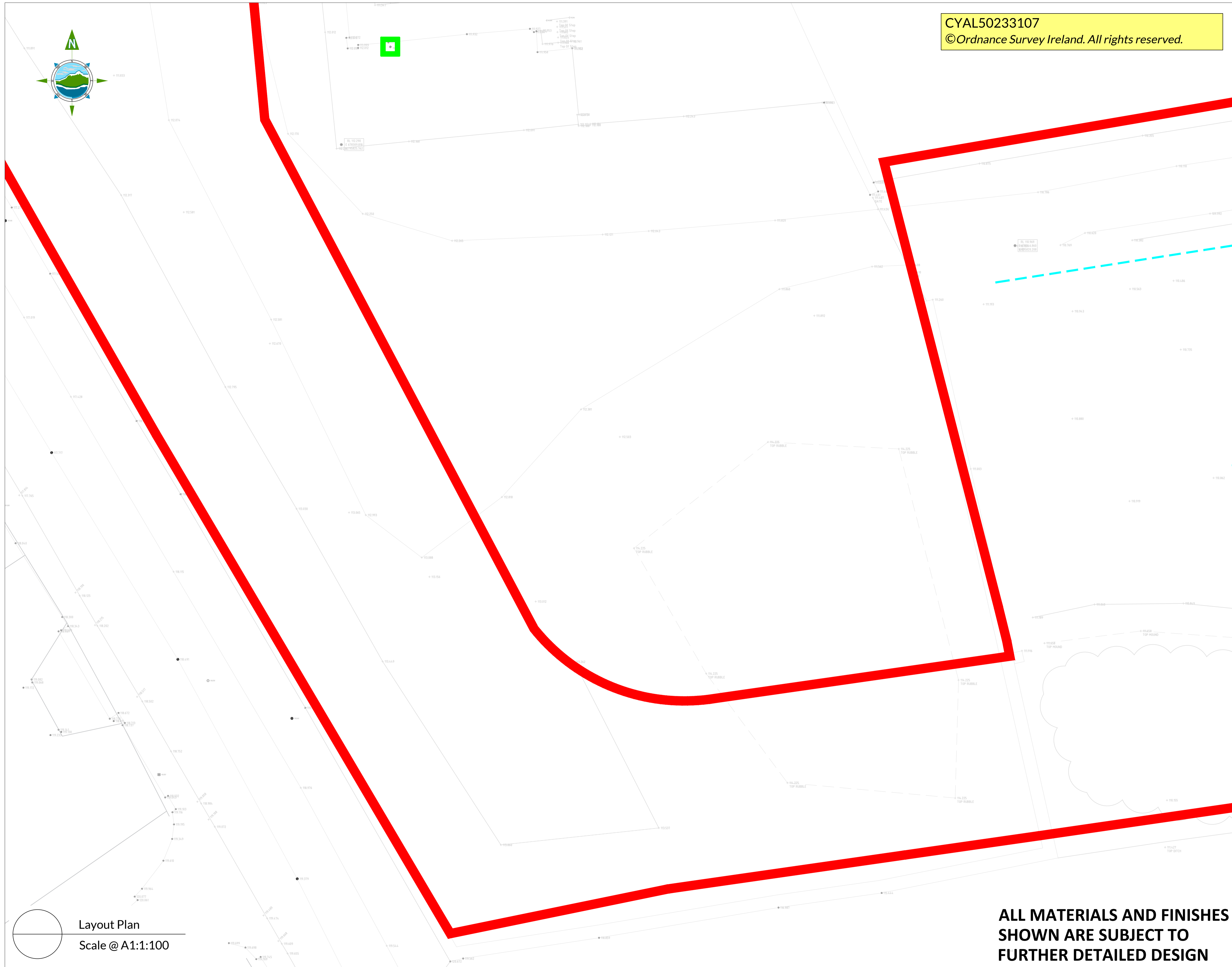

- LEGEND**
- EXISTING GULLY
  - EXISTING DOWNPIPE GULLY
  - PROPOSED GULLY
  - RETAINED GULLY
  - PROPOSED STORM LINE
  - EXISTING STORM LINE
  - SuDS - EXTENT OF TREE PIT
  - OVERFLOW FROM SuDS (TREE PIT)
  - ACO DRAIN WITH GRATING

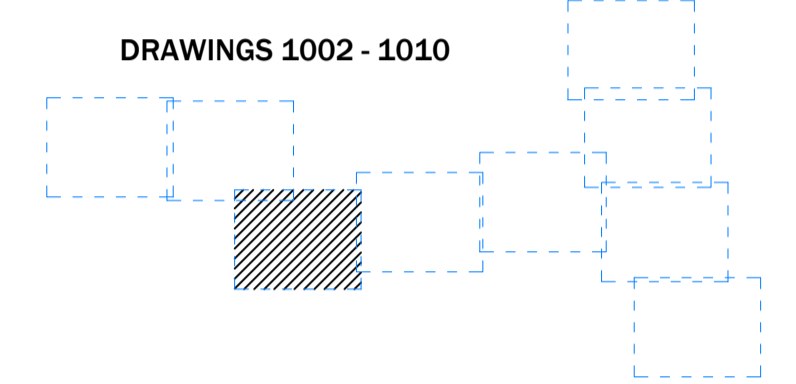

- NOTES:**
1. FIGURED DIMENSIONS ONLY TO BE TAKEN FROM THIS DRAWING
  2. ALL DRAWINGS TO BE CHECKED BY THE CONTRACTOR ON SITE
- ENGINEER TO BE INFORMED BY THE CONTRACTOR OF ANY DISCREPANCIES BEFORE ANY WORKS COMMENCES
- ALL LEVELS SHOWN RELATE TO ORDNANCE SURVEY DATUM AT MALIN HEAD, THE GEOGRAPHIC COORDINATE SYSTEM IS TO IRISH TRANSVERSE MERCATOR (ITM)

D01	Oct 22	Draft Issue for review	JD JN
Rev.	Date	Description	By Chkd
Client		Comhairle Contae an Chabháin Cavan County Council	
Project		Kingscourt Public Realm Enhancement Scheme	
Title		Preliminary Drainage Design	
		Sheet 8 of 9	

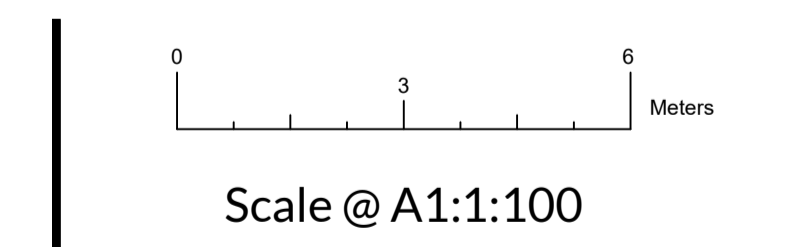

Prepared by:	Checked	Date
JD	JN	Oct 2022
Project Director	S. Kelly	
Drawing Status	Draft	

**TOBIN** CONSULTING ENGINEERS

TOBIN Consulting Engineers will not be liable for any use of this document for any purpose other than that for which it was originally prepared and provided. Except where specifically and explicitly agreed in writing by TOBIN Consulting Engineers, the copyright holder, no part of this document may be reproduced or transmitted in any form and this document shall not be relied upon by any third party for any purpose.

Drawing No. **11257 - 1007** **D01**

Layout Plan  
Scale @ A1:1:100

**ALL MATERIALS AND FINISHES SHOWN ARE SUBJECT TO FURTHER DETAILED DESIGN**



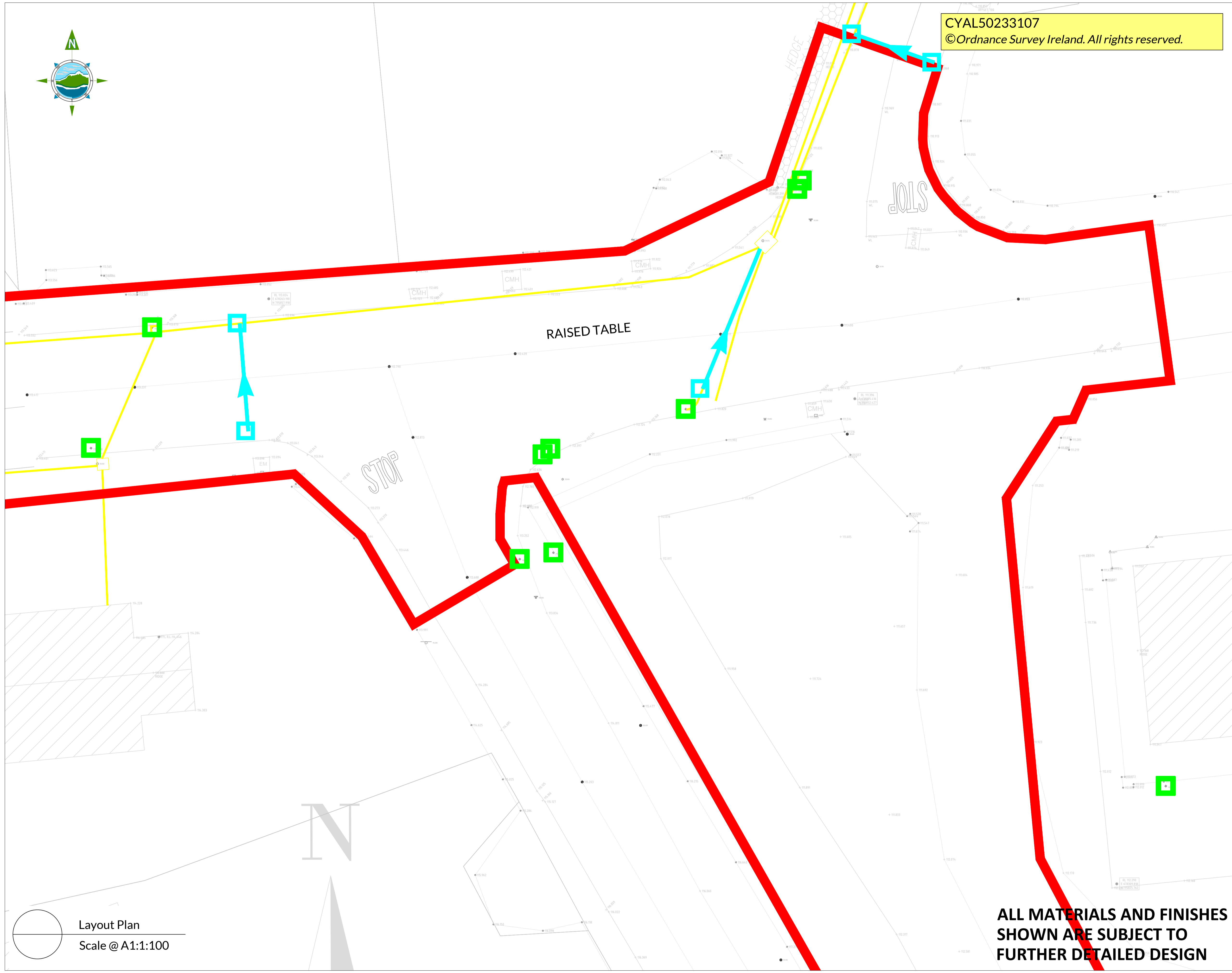

- LEGEND**
- EXISTING GULLY
  - EXISTING DOWNPIPE GULLY
  - PROPOSED GULLY
  - RETAINED GULLY
  - PROPOSED STORM LINE
  - EXISTING STORM LINE
  - SuDS - EXTENT OF TREE PIT
  - OVERFLOW FROM SuDS (TREE PIT)
  - ACO DRAIN WITH GRATING

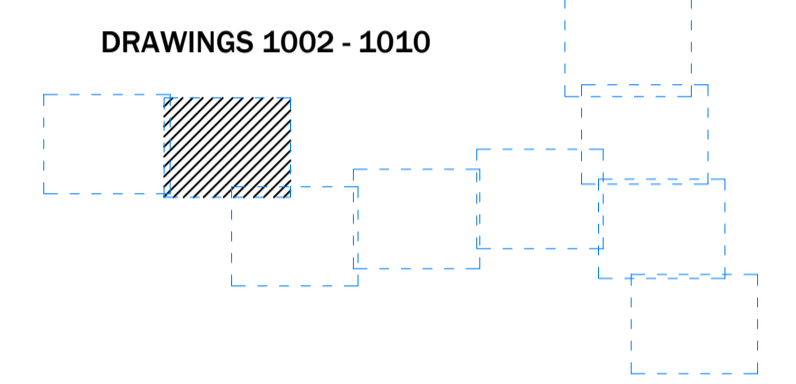

- NOTES:**
- FIGURED DIMENSIONS ONLY TO BE TAKEN FROM THIS DRAWING
  - ALL DRAWINGS TO BE CHECKED BY THE CONTRACTOR ON SITE
- ENGINEER TO BE INFORMED BY THE CONTRACTOR OF ANY DISCREPANCIES BEFORE ANY WORKS COMMENCES
- ALL LEVELS SHOWN RELATE TO ORDNANCE SURVEY DATUM AT MALIN HEAD, THE GEOGRAPHIC COORDINATE SYSTEM IS TO IRISH TRANSVERSE MERCATOR (ITM)

D01	Oct 22	Draft Issue for review	JD JN
Rev. Date	Description		By Chkd
Client	Comhairle Contae an Chabháin Cavan County Council		
Project	Kingscourt Public Realm Enhancement Scheme		
Title	Preliminary Drainage Design		
Sheet 8 of 9			

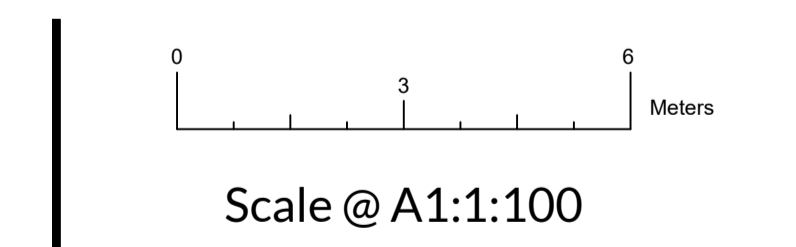

Prepared by:	Checked	Date
JD	JN	Oct 2022
Project Director	S. Kelly	
Drawing Status	Draft	

**TOBIN** CONSULTING ENGINEERS  
 CUNNANE STRATTON REYNOLDS LAND PLANNING & DESIGN  
 architects

TOBIN Consulting Engineers will not be liable for any use of this document for any purpose other than that for which it was originally prepared and provided. Except where specifically and explicitly agreed in writing by TOBIN Consulting Engineers, as copyright holder, no part of this document may be reproduced or transmitted in any form and this document shall not be relied upon by any third party for any purpose.

Drawing No. **11257 - 1008** ISSUE **D01**

Layout Plan  
Scale @ A1:1:100

**ALL MATERIALS AND FINISHES SHOWN ARE SUBJECT TO FURTHER DETAILED DESIGN**

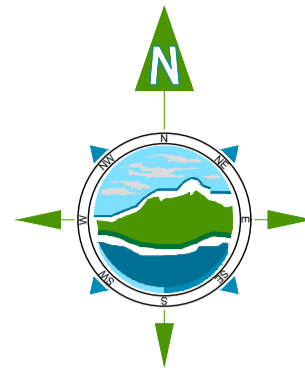

CYAL50233107  
© Ordnance Survey Ireland. All rights reserved.

LEGEND

-  EXISTING GULLY
-  EXISTING DOWNPIPE GULLY
-  PROPOSED GULLY
-  RETAINED GULLY
-  PROPOSED STORM LINE
-  EXISTING STORM LINE
-  SuDS - EXTENT OF TREE PIT
-  OVERFLOW FROM SuDS (TREE PIT)
-  ACO DRAIN WITH GRATING

DRAWINGS 1002 - 1010

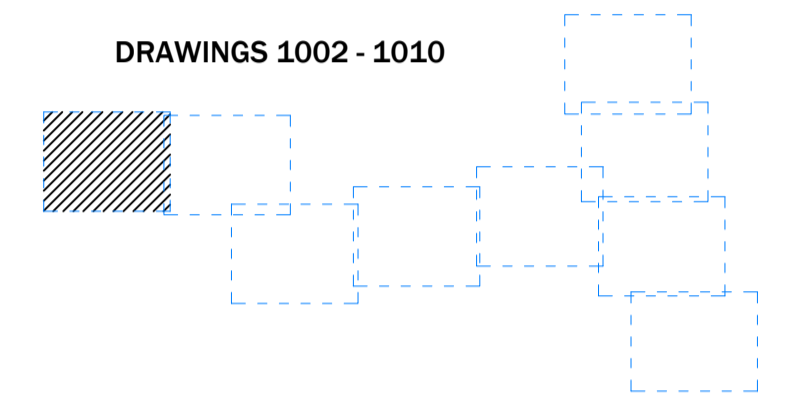

NOTES:

1. FIGURED DIMENSIONS ONLY TO BE TAKEN FROM THIS DRAWING
  2. ALL DRAWINGS TO BE CHECKED BY THE CONTRACTOR ON SITE
- ENGINEER TO BE INFORMED BY THE CONTRACTOR OF ANY DISCREPANCIES BEFORE ANY WORKS COMMENCES
- ALL LEVELS SHOWN RELATE TO ORDNANCE SURVEY DATUM AT MALIN HEAD, THE GEOGRAPHIC COORDINATE SYSTEM IS TO IRISH TRANSVERSE MERCATOR (ITM)

D01	Oct 22	Draft Issue for review	JD	JN
Rev.	Date	Description	By	Chkd
Client		 Comhairle Contae an Chabháin Cavan County Council		
Project		Kingscourt Public Realm Enhancement Scheme		
Title		Preliminary Drainage Design		
		Sheet 8 of 9		

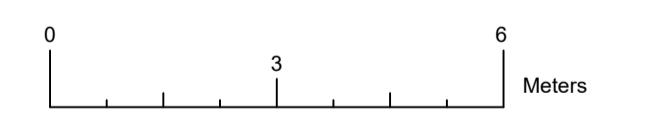

Scale @ A1:1:100

Prepared by:	Checked	Date
JD	JN	Oct 2022
Project Director	S. Kelly	
Drawing Status	Draft	



TOBIN CONSULTING ENGINEERS will not be liable for any use of this document for any purpose other than that for which it was originally prepared and provided. Except where specifically and explicitly agreed in writing by TOBIN Consulting Engineers, as copyright holder, no part of this document may be reproduced or transmitted in any form and this document shall not be relied upon by any third party for any purpose.

Drawing No. 11257 - 1009 ISSUE D01

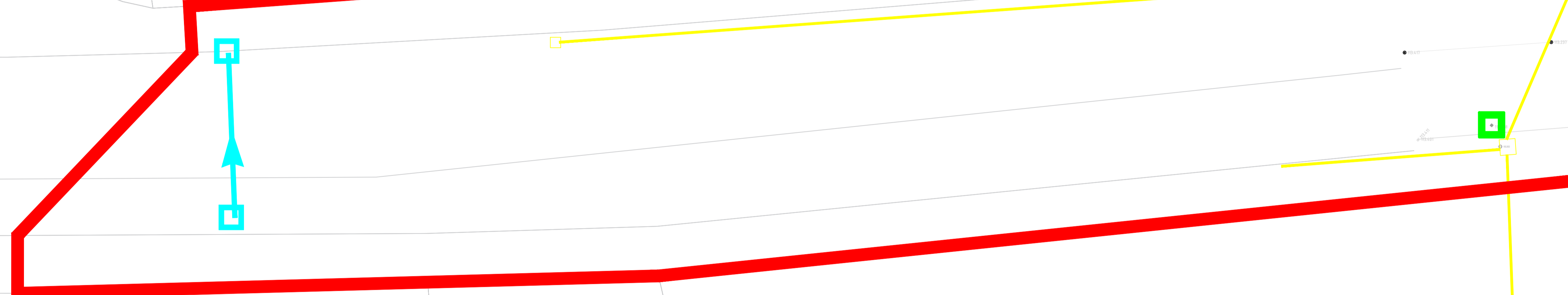

**ALL MATERIALS AND FINISHES SHOWN ARE SUBJECT TO FURTHER DETAILED DESIGN**

Layout Plan  
Scale @ A1:1:100